

# CHAINS

ROLLER CHAINS <b>TPM</b> <sup>®</sup>	page 3
ROLLER CHAINS <b>QRC</b> <sup>®</sup>	5
CHAIN PLATE STRAIGHT <b>QRC</b> <sup>®</sup>	8
CHAINS PINS DRILLED <b>QRC</b> <sup>®</sup>	9
ROLLER CHAINS <b>RCX</b> <sup>®</sup>	10
TRANSPORT CHAINS <b>CRT</b> <sup>®</sup>	12





COUPLING



OFFSET



CHAINS MANUFACTURED  
BY AN **ISO 9001** CERTIFIED  
FACTORY

Pack of 10m or 100m

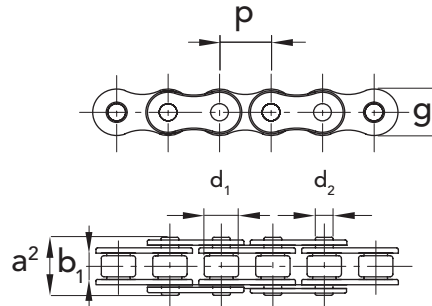

f = resistant surface

## SIMPLE

ISO N.	CHAIN P. NUMBER	COUPLING P. NUMBER	OFFSET P. NUMBER	P		b <sub>1</sub> min. mm	d <sub>2</sub> mm	d <sub>1</sub> max mm	a <sup>2</sup> max mm	g max mm	f cm <sup>2</sup>	breaking load N. mm <sup>2</sup>	kg/m =
				mm	inch								
081-1	70110008	70110058	70110088	12,7	1/2"	3,3	3,59	7,75	10,2	9,9	0,2	7200	0,28
083-1	70111008	70111058	70111088	12,7	1/2"	4,88	4,09	7,75	12,9	10,3	0,32	9200	0,42
084-1	70171008	70171058	70171088	12,7	1/2"	4,88	4,09	7,75	14,8	11,15	0,35	11000	0,59
084-1	72171008	-	-	12,7	1/2"	-	-	7,75	-	-	-	-	-

Please note: all TPM® chains are subject to pretensioning.  
This operation is made in order to fix dimension and stretching.

CAD drawings available on our site  
[www.chiaravalli.com](http://www.chiaravalli.com)

Quantity, availability and prices  
on B2B Chiaravalli



**OFFSET  
SIMPLE**

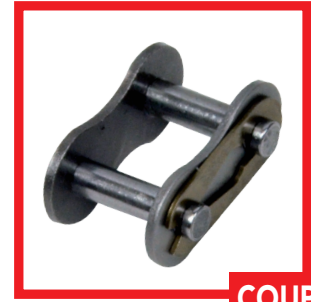

**COUPLING**

(\*)

**SIMPLE - CLIP**



ONLY FOR  
ARTICLE  
O5 B1

**OFFSET  
WITH 3 ROLLERS**



**COUPLING**

(◆)

**SIMPLE - COTTER PIN**



**OFFSET  
DOUBLE**



**COUPLING  
DOUBLE**



**OFFSET  
TRIPLE**



**COUPLING  
TRIPLE**

(\*) COUPLINGS with CLIP

(\*) COUPLINGS with CLIP part number ....5057  
(◆) and/or COTTER PIN part number ....5157

(◆) COUPLINGS with COTTER PIN

from 04 (B1, B2, B3)  
to 12 (B1, B2, B3)

16 (B1, B2, B3)

from 20 (B1, B2, B3)  
to 32 (B1, B2, B3)



CHAINS MANUFACTURED  
BY AN ISO 9001 CERTIFIED  
FACTORY

Pack of 5m

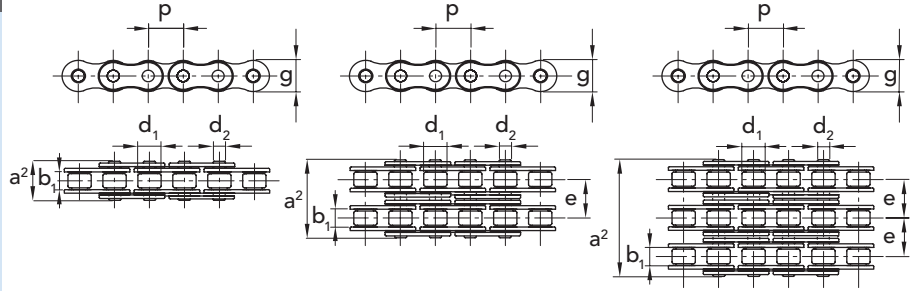

f = resistant surface

ROLLER CHAINS EUROPEAN SERIES QRC®

4

### SIMPLE

ISO N.	COUPLING			OFFSET		P		b <sub>1</sub>	d <sub>2</sub>	d <sub>1</sub>	a <sup>2</sup>	g	f	breaking load N. min.	kg/m =
	PART NUMBER	PART NUMBER	PART NUMBER	mm	inch	min. mm	mm								
04 B-1	70106007	70106057	70106087	6	-	2,80	1,85	4	7,4	5	0,07	2800	0,12		
05 B-1	70108007	70108057	70108087	8	-	3,00	2,31	5	8,6	7,11	0,11	4700	0,18		
06 B-1	70109007	70109057	70109087	9,525	3/8"	5,72	3,28	6,35	13,5	8,26	0,28	8200	0,4		
08 B-1	70112007	70112057	70112087	12,7	1/2"	7,75	4,45	8,51	17	11,81	0,5	16400	0,68		
10 B-1	70115007	70115057	70115087	15,875	5/8"	9,65	5,08	10,16	19,6	14,73	0,67	20500	0,91		
12 B-1	70119007	70119057	70119087	19,05	3/4"	11,68	5,72	12,07	22,7	16,13	0,89	26500	1,12		
16 B-1	70125007	70125057	70125087	25,40	1"	17,02	8,28	15,88	36,1	21,08	2,1	52500	2,59		
16 B-1 (♦)	70125157	con coppiglia		25,40	1"	17,02	8,28	15,88	36,1	21,08	2,1	52500	2,59		
20 B-1	70131007	70131057	70131087	31,75	1 1/4"	19,56	10,19	19,05	43,2	26,42	2,95	85500	3,68		
24 B-1	70138007	70138057	70138087	38,1	1 1/2"	25,40	14,63	25,4	53,4	33,4	5,54	153900	6,85		
28 B-1	70144007	70144057	70144087	44,45	1 3/4"	30,99	15,9	27,94	65,1	37,08	7,4	180000	8,56		
32 B-1	70150007	70150057	70150087	50,8	2"	38,10	17,81	29,21	67,4	42,29	8,11	230000	9,49		

### DOUBLE

ISO N.	COUPLING			OFFSET		P		b <sub>1</sub>	d <sub>2</sub>	d <sub>1</sub>	a <sup>2</sup>	g	f	breaking load N. mm <sup>2</sup>	kg/m =
	PART NUMBER	PART NUMBER	PART NUMBER	mm	inch	min. mm	mm								
06 B-2	70209007	70209057	70209087	9,525	3/8"	5,72	3,28	6,35	23,8	8,26	10,24	0,55	15500	0,76	
08 B-2	70212007	70212057	70212087	12,7	1/2"	7,75	4,45	8,51	31	11,81	13,92	1	28500	1,31	
10 B-2	70215007	70215057	70215087	15,875	5/8"	9,65	5,08	10,16	36,2	14,73	16,59	1,34	41000	1,79	
12 B-2	70219007	70219057	70219087	19,05	3/4"	11,68	5,72	12,07	42,2	16,13	19,46	1,78	53000	2,22	
16 B-2	70225007	70225057	70225087	25,40	1"	17,02	8,28	15,88	68	21,08	31,88	4,21	99500	5,03	
20 B-2	70231007	70231057	70231087	31,75	1 1/4"	19,56	10,19	19,05	79,7	26,42	35,45	5,91	162000	7,33	
24 B-2	70238007	70238057	70238087	38,1	1 1/2"	25,40	14,63	25,4	101,8	33,4	48,36	11,09	293000	13,5	
28 B-2	70244007	70244057	70244087	44,45	1 3/4"	30,99	15,9	27,94	124,7	37,08	59,56	14,81	344000	16,96	
32 B-2	70250007	70250057	70250087	50,8	2"	30,99	17,81	29,21	126	42,29	58,55	16,23	440000	18,74	

### TRIPLE

ISO N.	COUPLING			OFFSET		P		b <sub>1</sub>	d <sub>2</sub>	d <sub>1</sub>	a <sup>2</sup>	g	f	breaking load N. mm <sup>2</sup>	kg/m =
	PART NUMBER	PART NUMBER	PART NUMBER	mm	inch	min. mm	mm								
06 B-3	70309007	70309057	70309087	9,525	3/8"	5,72	3,28	6,35	34	8,26	10,24	0,83	22800	1,12	
08 B-3	70312007	70312057	70312087	12,7	1/2"	7,75	4,45	8,51	44,9	11,81	13,92	1,5	41000	1,94	
10 B-3	70315007	70315057	70315087	15,875	5/8"	9,65	5,08	10,16	52,8	14,73	16,59	2,02	61500	2,68	
12 B-3	70319007	70319057	70319087	19,05	3/4"	11,68	5,72	12,07	61,7	16,13	19,46	2,68	80000	3,32	
16 B-3	70325007	70325057	70325087	25,40	1"	17,02	8,28	15,88	99,9	21,08	31,88	6,32	149000	7,65	
20 B-3	70331007	70331057	70331087	31,75	1 1/4"	19,56	10,19	19,05	116,1	26,42	35,45	8,86	244000	10,96	
24 B-3	70338007	70338057	70338087	38,1	1 1/2"	25,40	14,63	25,4	150,2	33,4	48,36	16,64	438000	20,2	
28 B-3	70344007	70344057	70344087	44,45	1 3/4"	30,99	15,9	27,94	184,3	37,08	59,56	22,21	516000	25,38	
32 B-3	70350007	70350057	70350087	50,8	2"	30,99	17,81	29,21	184,5	42,29	58,55	24,34	671000	28,04	

Please note: all QRC® chains are subject to pretensioning.  
This operation is made in order to fix dimension and stretching.

CAD drawings available on our site  
[www.chiaravalli.com](http://www.chiaravalli.com)

Quantity, availability and prices  
on B2B Chiaravalli





CHAINS MANUFACTURED  
BY AN **ISO 9001** CERTIFIED  
FACTORY

Pack of 5m

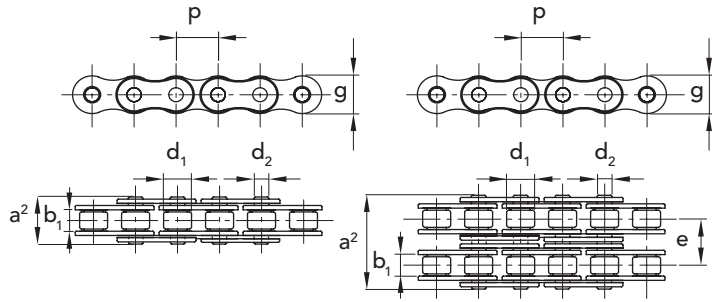

f = resistant surface

### SIMPLE - STAINLESS STEEL AISI 304

ISO N.	CHAIN P. NUMBER	COUPLING P. NUMBER	OFFSET P. NUMBER	P	b <sub>1</sub>	d <sub>2</sub>	d <sub>1</sub>	a <sup>2</sup>	g	e	f	breaking load N. mm <sup>2</sup>	kg/m	
				mm	inch	min. mm	mm	max mm	max mm	max mm	mm	cm <sup>2</sup>	=	
05 B-1	74108007	74108057	74108087	8,00	-	3	2,31	5	8,6	7,11	0,11	0,18	3400	0,18
06 B-1	74109007	74109057	74109087	9,53	3/8"	5,72	3,28	6,35	13,5	8,26	0,28	0,41	4400	0,40
08 B-1	74112007	74112057	74112087	12,70	1/2"	7,75	4,45	8,51	17	11,81	0,5	0,7	9800	0,68
10 B-1	74115007	74115057	74115087	15,88	5/8"	9,65	5,08	10,16	19,6	14,73	0,67	0,95	13600	0,91
12 B-1	74119007	74119057	74119087	19,05	3/4"	11,68	5,72	12,07	22,7	16,13	0,89	1,25	15000	1,12
16 B-1	74125007	74125057	74125087	25,40	1"	17,02	8,28	15,88	36,1	21,08	2,1	2,7	39500	2,59

### DOUBLE - STAINLESS STEEL AISI 304

ISO N.	CHAIN P. NUMBER	COUPLING P. NUMBER	OFFSET P. NUMBER	P	b <sub>1</sub>	d <sub>2</sub>	d <sub>1</sub>	a <sup>2</sup>	g	e	f	breaking load N. mm <sup>2</sup>	kg/m	
				mm	inch	min. mm	mm	max mm	max mm	max mm	mm	cm <sup>2</sup>	=	
06 B-2	74209007	74209057	74209087	9,53	3/8"	5,72	3,28	6,35	23,8	8,26	10,24	0,55	8400	1,35
08 B-2	74212007	74212057	74212087	12,70	1/2"	7,75	4,45	8,51	31	11,81	13,92	1	16950	1,85
10 B-2	74215007	74215057	74215087	15,88	5/8"	9,65	5,08	10,16	36,2	14,73	16,59	1,34	27000	2,20
12 B-2	74219007	74219057	74219087	19,05	3/4"	11,68	5,72	12,07	42,2	16,13	19,46	1,78	29700	2,50
16 B-2	74225007	74225057	74225087	25,40	1"	17,02	8,28	15,88	68	21,08	31,88	4,21	69000	5,40

### NICKEL - PLATED

ISO N.	CHAIN P. NUMBER	COUPLING P. NUMBER	OFFSET P. NUMBER	P	b <sub>1</sub>	d <sub>2</sub>	d <sub>1</sub>	a <sup>2</sup>	g	f	breaking load N. mm <sup>2</sup>	kg/m	
				mm	inch	min. mm	mm	max mm	max mm	max mm	cm <sup>2</sup>	=	
06 B-1	73109007	73109057	73109087	9,53	3/8"	5,72	3,28	6,35	13,5	8,26	0,28	8200	0,41
08 B-1	73112007	73112057	73112087	12,70	1/2"	7,75	4,45	8,51	17	11,81	0,5	16400	0,70
10 B-1	73115007	73115057	73115087	15,88	5/8"	9,65	5,08	10,16	19,6	14,73	0,67	20500	0,95
12 B-1	73119007	73119057	73119087	19,05	3/4"	11,68	5,72	12,07	22,7	16,13	0,89	26500	1,25
16 B-1	73125007	73125057	73125087	25,40	1"	17,02	8,28	15,88	36,1	21,08	2,1	52500	2,70

Please note: all QRC® chains are subject to pretensioning.  
This operation is made in order to fix dimension and stretching.

CAD drawings available on our site  
[www.chiaravalli.com](http://www.chiaravalli.com)

Quantity, availability and prices  
on B2B Chiaravalli





## CHAINS MANUFACTURED BY AN ISO 9001 CERTIFIED FACTORY

Please note: all QRC® chains are subject to pretensioning. This operation is made in order to fix dimension and stretching.

### Pack of 5m

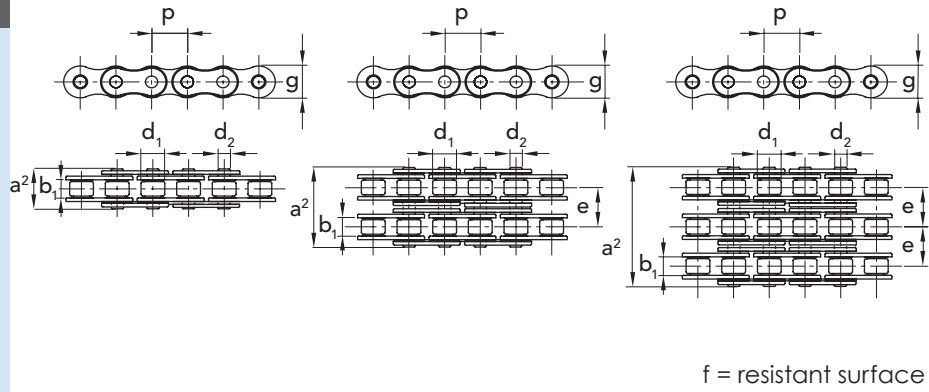

ROLLER CHAINS AMERICAN SERIES QRC®

#### SIMPLE "ANSI" ASA

ANSI N.	CHAIN P. NUMBER	COUPLING P. NUMBER	OFFSET P. NUMBER	P		b <sub>1</sub> min. mm	d <sub>2</sub> mm	d <sub>1</sub> max mm	a <sup>2</sup> max mm	g max mm	f cm <sup>2</sup>	breaking load N. mm <sup>2</sup>	kg/m =
				mm	inch								
35-1	71103007	71103057	71103087	9,525	3/8"	4,77	3,58	5,08	13,2	9,05	0,27	7350	0,34
40-1	71104007	71104057	71104087	12,7	1/2"	7,95	3,96	7,92	17,8	12,07	0,44	12900	0,63
50-1	71105007	71105057	71105087	15,875	5/8"	9,53	5,08	10,16	21,8	15,09	0,7	20200	1,04
60-1	71106007	71106057	71106087	19,05	3/4"	12,7	5,94	11,91	26,9	18,08	1,06	28900	1,52
80-1	71108007	71108057	71108087	25,40	1"	15,88	7,92	15,88	33,5	24,13	1,79	51300	2,58
100-1	71110007	71110057	71110087	31,75	1 1/4"	19,05	9,53	19,05	41,1	30,18	2,62	80200	3,85
120-1	71112007	71112057	71112087	38,1	1 1/2"	25,4	11,1	22,23	50,8	36,2	3,94	115000	5,61
140-1	71114007	71114057	71114087	44,45	1 3/4"	25,4	12,7	25,4	54,9	42,24	4,72	156300	7,24
160-1	71116007	71116057	71116087	50,8	2"	31,75	14,27	28,58	65,5	48,26	6,5	205500	9,91

#### DOUBLE "ANSI" ASA

ANSI N.	CHAIN P. NUMBER	COUPLING P. NUMBER	OFFSET P. NUMBER	P		b <sub>1</sub> min. mm	d <sub>2</sub> mm	d <sub>1</sub> max mm	a <sup>2</sup> max mm	g max mm	e mm	f cm <sup>2</sup>	breaking load N. mm <sup>2</sup>	kg/m =
				mm	inch									
35-2	71203007	71203057	71203087	9,525	3/8"	4,77	3,58	5,08	21,6	9,05	10,13	0,54	14700	0,67
40-2	71204007	71204057	71204087	12,7	1/2"	7,95	3,96	7,92	32,3	12,07	14,38	0,88	25600	1,26
50-2	71205007	71205057	71205087	15,875	5/8"	9,53	5,08	10,16	39,9	15,09	18,11	1,4	40400	2,05
60-2	71206007	71206057	71206087	19,05	3/4"	12,7	5,94	11,91	49,8	18,08	22,78	2,12	57800	3,01
80-2	71208007	71208057	71208087	25,40	1"	15,88	7,92	15,88	62,7	24,13	29,29	3,58	102700	5,13
100-2	71210007	71210057	71210087	31,75	1 1/4"	19,05	9,53	19,05	77	30,18	35,76	5,24	160400	7,64
120-2	71212007	71212057	71212087	38,1	1 1/2"	25,4	11,1	22,23	96,3	36,2	45,44	7,88	230000	11,13
140-2	71214007	71214057	71214087	44,45	1 3/4"	25,4	12,7	25,4	103,6	42,24	48,87	9,44	312600	14,37
160-2	71216007	71216057	71216087	50,8	2"	31,75	14,27	28,58	124,2	48,26	58,55	13	411000	19,68

#### TRIPLE "ANSI" ASA

ANSI N.	CHAIN P. NUMBER	COUPLING P. NUMBER	OFFSET P. NUMBER	P		b <sub>1</sub> min. mm	d <sub>2</sub> mm	d <sub>1</sub> max mm	a <sup>2</sup> max mm	g max mm	e mm	f cm <sup>2</sup>	breaking load N. mm <sup>2</sup>	kg/m =
				mm	inch									
35-3	71303007	71303057	71303087	9,525	3/8"	4,77	3,58	5,08	31,8	9,05	10,13	0,81	22050	0,99
40-3	71304007	71304057	71304087	12,7	1/2"	7,95	3,96	7,92	46,7	12,07	14,38	1,32	38300	1,98
50-3	71305007	71305057	71305087	15,875	5/8"	9,53	5,08	10,16	57,9	15,09	18,11	2,1	60600	3,06
60-3	71306007	71306057	71306087	19,05	3/4"	12,7	5,94	11,91	72,6	18,08	22,78	3,18	86700	4,50
80-3	71308007	71308057	71308087	25,40	1"	15,88	7,92	15,88	91,7	24,13	29,29	5,37	154100	7,67
100-3	71310007	71310057	71310087	31,75	1 1/4"	19,05	9,53	19,05	113	30,18	35,76	7,86	240600	11,43
120-3	71312007	71312057	71312087	38,1	1 1/2"	25,4	11,1	22,23	141,7	36,2	45,44	11,82	345000	16,67
140-3	71314007	71314057	71314087	44,45	1 3/4"	25,4	12,7	25,4	152,4	42,24	48,87	14,16	468900	21,51
160-3	71316007	71316057	71316087	50,8	2"	31,75	14,27	28,58	182,9	48,26	58,55	19,5	616400	29,45

#### SIMPLE REINFORCED

ANSI N.	CHAIN P. NUMBER	COUPLING P. NUMBER	OFFSET P. NUMBER	P		b <sub>1</sub> min. mm	d <sub>2</sub> mm	d <sub>1</sub> max mm	a <sup>2</sup> max mm	g max mm	f cm <sup>2</sup>	breaking load N. min.	kg/m =
				mm	inch								
60-H1	72906007	72906057	72906087	19,05	3/4"	12,7	5,94	11,91	28,9	18,08	1,06	49000	1,70
80-H1	72908007	72908057	72908087	25,40	1"	15,88	7,92	15,88	36,5	24,13	1,79	84800	2,90

CAD drawings available on our site [www.chiaravalli.com](http://www.chiaravalli.com)

Quantity, availability and prices on B2B Chiaravalli



CHAINS MANUFACTURED  
BY AN ISO 9001 CERTIFIED  
FACTORY

Pack of 5m

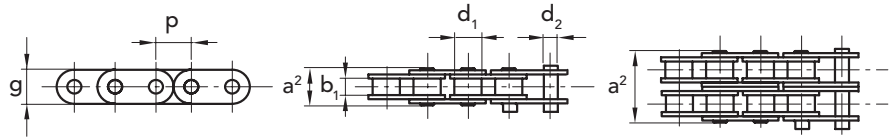

f = resistant surface

#### SIMPLE PLATE STRAIGHT

ISO N.	CHAIN	COUPLING	OFFSET	P		b <sub>1</sub>	d <sub>2</sub>	d <sub>1</sub>	a <sup>2</sup>	g	f	breaking	kg/m
	P. NUMBER	P. NUMBER	P. NUMBER	mm	inch	min. mm	mm	max mm	max mm	max mm	cm <sup>2</sup>	N. mm <sup>2</sup>	=
08B1	74112607	74112657	74112687	12,70	1/2"	7,75	4,45	8,51	17,0	11,81	0,5	16400	0,80
10B1	74115607	74115657	74115687	15,875	5/8"	9,65	5,08	10,16	19,6	14,73	0,67	20600	1,00
12B1	74119607	74119657	74119687	19,05	3/4"	11,68	5,72	12,07	22,7	16,13	0,89	26600	1,30
16B1	74125607	74125657	74125687	25,40	1"	11,02	8,28	15,88	36,1	21,08	2,10	52700	2,90

#### DOUBLE PLATE STRAIGHT

ISO N.	CHAIN	COUPLING	OFFSET	P		b <sub>1</sub>	d <sub>2</sub>	d <sub>1</sub>	a <sup>2</sup>	g	f	breaking	kg/m
	P. NUMBER	P. NUMBER	P. NUMBER	mm	inch	min. mm	mm	max mm	max mm	max mm	cm <sup>2</sup>	N. mm <sup>2</sup>	=
10B2	74215607	74215657	70215087	15,88	5/8"	9,65	5,08	10,16	36,2	14,73	1,34	41100	2,50
12B2	74219607	74219657	70219087	19,05	3/4"	11,68	5,72	12,07	42,2	16,13	1,78	53300	2,60

Please note: all QRC® chains are subject to pretensioning. This operation is made in order to fix dimension and stretching.

CAD drawings available on our site  
[www.chiaravalli.com](http://www.chiaravalli.com)

Quantity, availability and prices  
on B2B Chiaravalli

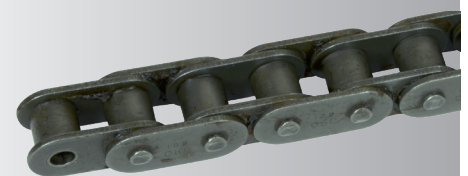





CHAINS MANUFACTURED  
BY AN ISO 9001 CERTIFIED  
FACTORY

Pack of 5m

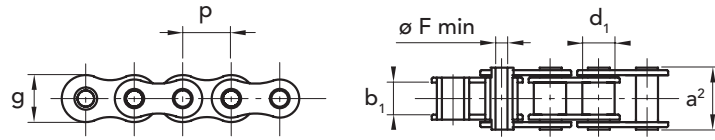

f = resistant surface

### PINS DRILLED

RIFERIM. N.	CHAIN P. NUMBER	COUPLING P. NUMBER	OFFSET P. NUMBER	P		b <sub>1</sub>	d <sub>1</sub>	a <sup>2</sup>	Ø F	g	f	breaking load N. mm <sup>2</sup>	kg/m =
				mm	inch	min. mm	mm	max mm	max mm	max mm	cm <sup>2</sup>		
08 BHP-1	74112707	74112757	74112787	12,7	1/2"	7,75	8,51	17,00	4,4	11,7	0,7	13.500	0,50
10 BHP-1	74115707	74115757	74115787	15,875	5/8"	9,65	10,16	21,00	5,1	14	1,0	20.000	0,80

CHAINS PINS DRILLED QRC®

Please note: all QRC® chains are subject to pretensioning. This operation is made in order to fix dimension and stretching.

CAD drawings available on our site [www.chiaravalli.com](http://www.chiaravalli.com)

Quantity, availability and prices on B2B Chiaravalli





# ROLLER CHAINS EUROPEAN SERIES RCX®



**OFFSET  
SIMPLE**



**COUPLING  
SIMPLE**



**OFFSET  
DOUBLE**



**COUPLING  
DOUBLE**



**OFFSET  
TRIPLE**



**COUPLING  
TRIPLE**



CHAINS MANUFACTURED  
BY AN ISO 9001 CERTIFIED  
FACTORY

Pack of 5m

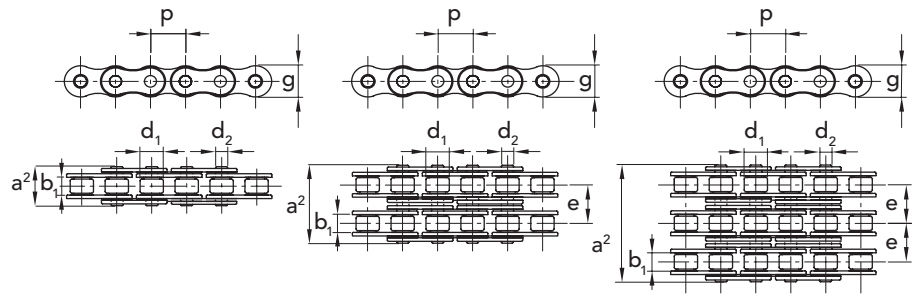

f = resistant surface

### SIMPLE

ISO N.	CHAIN P. NUMBER	COUPLING P. NUMBER	OFFSET P. NUMBER	P	b <sub>1</sub>	d <sub>2</sub>	d <sub>1</sub>	a <sup>2</sup>	g	f	breaking load N. mm <sup>2</sup>	kg/m =
				mm inch	min. mm	mm	max mm	max mm	max mm	cm <sup>2</sup>		
04 1	70106006	70106056	70106086	6 -	2,80	1,85	4,00	7,40	5,00	0,07	3000	0,12
05 B-1	70108006	70108056	70108086	8 -	3,00	2,31	5,00	8,60	7,11	0,11	5000	0,18
06 B-1	70109006	70109056	70109086	9,525 3/8"	5,72	3,28	6,35	13,5	8,26	0,28	9000	0,41
08 B-1	70112006	70112056	70112086	12,7 1/2"	7,75	4,45	8,51	17,0	11,81	0,50	18000	0,70
10 B-1	70115006	70115056	70115086	15,875 5/8"	9,65	5,08	10,16	19,6	14,73	0,67	23500	0,95
12 B-1	70119006	70119056	70119086	19,05 3/4"	11,68	5,72	12,07	22,7	16,13	0,89	29400	1,25
16 B-1	70125006	70125056	70125086	25,40 1"	17,02	8,28	15,88	36,1	21,08	2,10	66700	2,70
20 B-1	70131006	70131056	70131086	31,75 1 1/4"	19,56	10,19	19,05	43,2	26,42	2,95	96000	3,60
24 B-1	70138006	70138056	70138086	38,1 1 1/2"	25,40	14,63	25,40	53,4	33,40	5,54	160000	6,70
32 B-1	70150006	70150056	70150086	50,8 2"	30,99	17,81	29,21	67,4	42,29	8,11	257800	10,50

### DOUBLE

ISO N.	CHAIN P. NUMBER	COUPLING P. NUMBER	OFFSET P. NUMBER	P	b <sub>1</sub>	d <sub>2</sub>	d <sub>1</sub>	a <sup>2</sup>	g	e	f	breaking load N. mm <sup>2</sup>	kg/m =
				mm inch	min. mm	mm	max mm	max mm	max mm	mm	cm <sup>2</sup>		
05 B-2	70208006	70208056	70208086	8 -	3,00	2,31	5,00	14,3	7,10	5,64	0,22	9800	0,36
06 B-2	70209006	70209056	70209086	9,525 3/8"	5,72	3,28	6,35	23,8	8,26	10,24	0,55	17000	0,78
08 B-2	70212006	70212056	70212086	12,7 1/2"	7,75	4,45	8,51	31,0	11,81	13,92	1,00	34000	1,35
10 B-2	70215006	70215056	70215086	15,875 5/8"	9,65	5,08	10,16	36,2	14,73	16,59	1,34	47000	1,85
12 B-2	70219006	70219056	70219086	19,05 3/4"	11,68	5,72	12,07	42,2	16,13	19,46	1,78	58000	2,50
16 B-2	70225006	70225056	70225086	25,40 1"	17,02	8,28	15,88	68,0	21,08	31,88	4,21	133200	5,40
20 B-2	70231006	70231056	70231086	31,75 1 1/4"	19,56	10,19	19,05	79,7	26,42	35,45	5,91	192000	7,20
24 B-2	70238006	70238056	70238086	38,1 1 1/2"	25,40	14,63	25,40	101,8	33,40	48,36	11,09	320500	13,50

### TRIPLE

ISO N.	CHAIN P. NUMBER	COUPLING P. NUMBER	OFFSET P. NUMBER	P	b <sub>1</sub>	d <sub>2</sub>	d <sub>1</sub>	a <sup>2</sup>	g	e	f	breaking load N. mm <sup>2</sup>	kg/m =
				mm inch	min. mm	mm	max mm	max mm	max mm	mm	cm <sup>2</sup>		
06 B-3	70309006	70309056	70309086	9,525 3/8"	5,72	3,28	6,35	34,0	8,26	10,24	0,83	26400	1,20
08 B-3	70312006	70312056	70312086	12,7 1/2"	7,75	4,45	8,51	44,9	11,81	13,92	1,50	49000	2,00
10 B-3	70315006	70315056	70315086	15,875 5/8"	9,65	5,08	10,16	52,8	14,73	16,59	2,02	70000	2,80
12 B-3	70319006	70319056	70319086	19,05 3/4"	11,68	5,72	12,07	61,7	16,13	19,46	2,68	88000	3,80
16 B-3	70325006	703225056	70325086	25,40 1"	17,02	8,28	15,88	99,9	21,08	31,88	6,32	196000	8,00

Please note: all RCX® chains are subject to pretensioning. This operation is made in order to fix dimension and stretching.



CAD drawings available on our site  
[www.chiaravalli.com](http://www.chiaravalli.com)

Quantity, availability and prices  
on B2B Chiaravalli

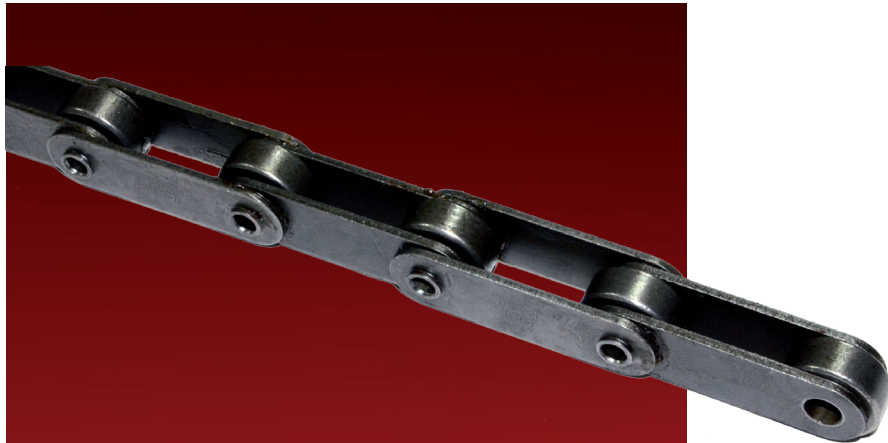

**COUPLING**

**2 ATTACKS TYPE K**



**COUPLING**

**1 ATTACK TYPE A**



**COUPLING**

**BOLTS DRILLED**



**COUPLING**

**SOLID COUPLING PINS**



**COUPLING**

**PIN SURFACE**



CHAINS MANUFACTURED  
BY AN **ISO 9001** CERTIFIED  
FACTORY

Pack of 5m

f = resistant surface

## SOLID COUPLING PINS

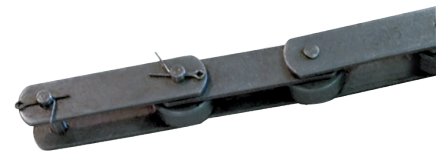
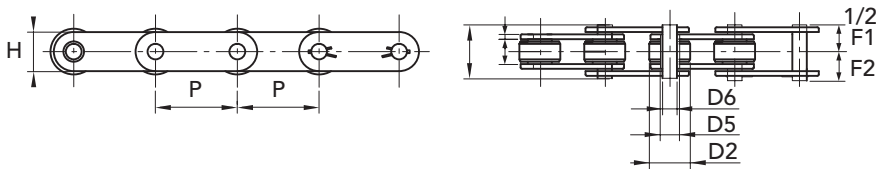

CHAIN	CHAIN P. NUMBER	COUPLING P. NUMBER	P mm	L mm	D2 mm	D5 mm	D6 mm	H mm	S mm	F1 mm	F2 mm	breaking load N. mm <sup>2</sup>	kg/m catena
1,1205	74502050	74502055	50	11,5	25	8,35	5,7	18	2,5	25,5	15,4	18000	1,70
1,1206	74502060	74502065	50	11,5	25	11	8	20	3	28,8	16,5	22000	2,10
1,1400	74504000	74504005	50	15	31	13,2	10	23	3	32,6	19,2	32000	3,00
1,1500	74505000	74505005	50	15	31	13,2	10	25	4	36,6	20,7	40000	3,90
1,1505	74505020	74505025	100	15	31	13,2	10	25	4	36,6	20,7	40000	2,90
1,1703	74507030	74507035	100	22	40	17	12	35	4	44	25	75000	4,9 0

## SOLID COUPLING PINS TIPE "B"

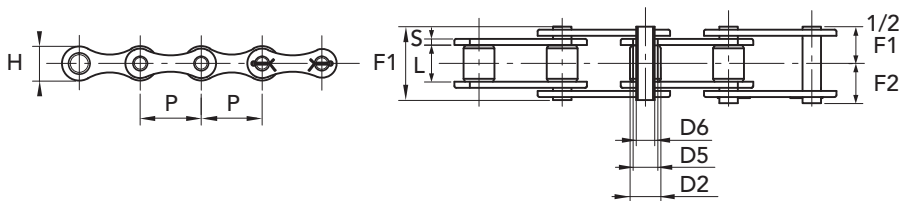

CHAIN	CHAIN P. NUMBER	COUPLING P. NUMBER	P mm	L mm	D2 mm	D5 mm	D6 mm	H mm	S mm	F1 mm	F2 mm	breaking load N. mm <sup>2</sup>	kg/m catena
1,1400 B	74514000	74514005	50	15	31	13,2	10	23	3	32,6	19,2	32000	2,50

## SOLID COUPLING PINS WITH ATTACHMENTS

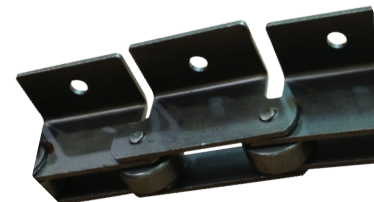
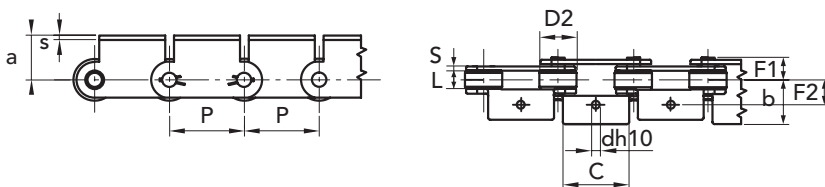

CHAIN	CHAIN P. NUMBER	COUPLING P. NUMBER	P mm	D2 mm	a mm	b mm	c mm	d mm	e mm	s mm	L mm	F2 mm	breaking load N. mm <sup>2</sup>	kg/m attacco
1.1205 A1-01	74522050	74522055	50	25	24	22	46	6,5	36	2,5	11,5	12,75	18000	2,51

CAD drawings available on our site  
[www.chiaravalli.com](http://www.chiaravalli.com)

Quantity, availability and prices  
on B2B Chiaravalli



TRANSPORT CHAINS CRT®

CHAINS MANUFACTURED BY AN ISO 9001 CERTIFIED FACTORY

Pack of 5m

f = resistant surface

**SOLID COUPLING PINS WITH ATTACHMENTS**

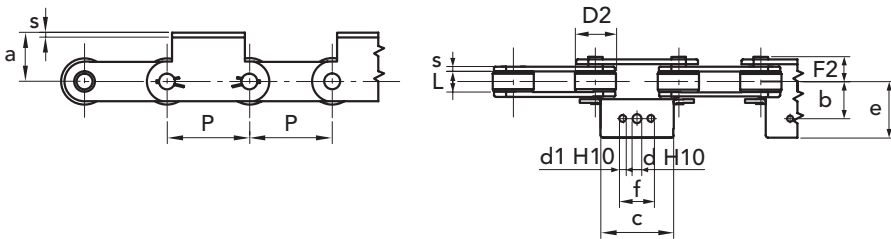

CHAIN	CHAIN P. NUMBER	COUPLING P. NUMBER	P mm	D2 mm	a mm	b mm	c mm	d mm	e mm	s mm	d1 mm	f mm	L mm	F2 mm	breaking load N. mm <sup>2</sup>	kg/m
1.1205 A1-02	74532050	74522055	50	25	24	22	46	6,5	36	2,5	-	-	11,5	12,75	18000	2,50
1.1400 A3-02	74534000	74534005	50	31	35	31	60	10,5	48,5	3	8,5	25	15	16,3	32000	4,23
1.1500 A3-02	74535000	74535005	50	31	35	32	45	10,5	48	4	8,5	25	15	18,7	40000	4,63

**SOLID COUPLING PINS WITH ATTACHMENTS**

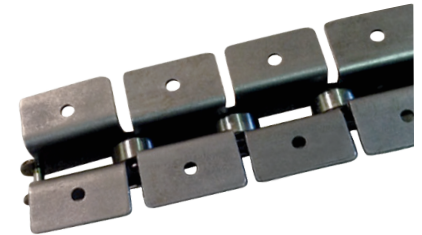
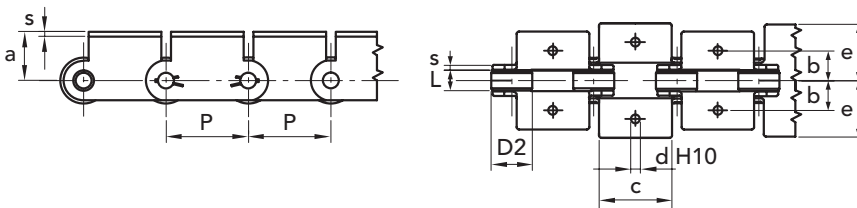

CHAIN	CHAIN P. NUMBER	COUPLING P. NUMBER	P mm	D2 mm	a mm	b mm	c mm	d mm	e mm	s mm	L mm	breaking load N. mm <sup>2</sup>	kg/m
1.1205 K1-01	74542050	74542055	50	25	24	22	46	6,5	36	2,5	11,5	18000	3,19

**SOLID COUPLING PINS WITH ATTACHMENTS**

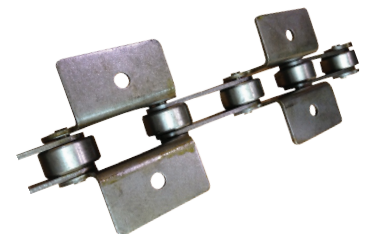
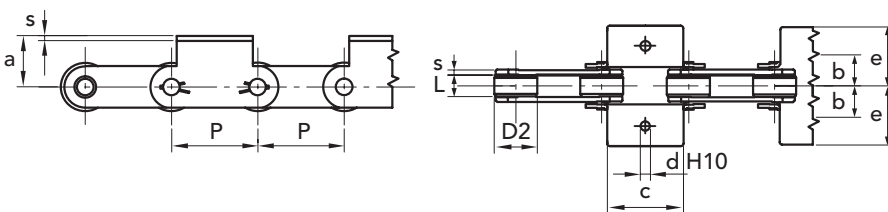

CHAIN	CHAIN P. NUMBER	COUPLING P. NUMBER	P mm	D2 mm	a mm	b mm	c mm	d mm	e mm	s mm	L mm	breaking load N. mm <sup>2</sup>	kg/m
1.1205 K1-02	74552050	74542055	50	25	24	22	46	6,5	36	2,5	11,5	18000	2,50

CAD drawings available on our site [www.chiaravalli.com](http://www.chiaravalli.com)

Quantity, availability and prices on B2B Chiaravalli



CHAINS MANUFACTURED BY AN ISO 9001 CERTIFIED FACTORY

Pack of 5m

f = resistant surface

### STUD PIERCED

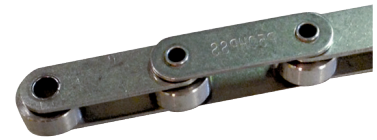
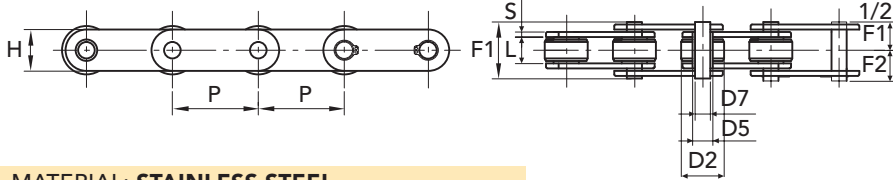

MATERIAL: STAINLESS STEEL

CHAIN	CHAIN P. NUMBER	COUPLING P. NUMBER	P mm	L mm	D2 mm	D5 mm	D6 mm	D7 mm	H mm	S mm	F1 mm	F2 mm	breaking load N. mm <sup>2</sup>	kg/m chain
1.2250	74602500	74602505	50	11,5	25	11	9	6,2	20	2,5	26	14,5	30000	1,80
1.2250 SS	74695400	74695405	50	11,5	25	11	9	6,2	20	2,5	26	14,5	20000	1,80
1.2400	74604000	74604005	50	15	31	17	14	10,2	25	3	31	17,5	35000	3,00
1.2500	74605000	74605005	50	15	31	17	14	10,2	25	4	35	19,5	40000	3,60
1.2501	74605010	74605015	75	15	31	17	14	10,2	25	4	35	19,5	40000	3,10
1.2502	74605020	74605025	100	15	31	17	14	10,2	25	4	35	19,5	40000	2,60

### STUD PIERCED

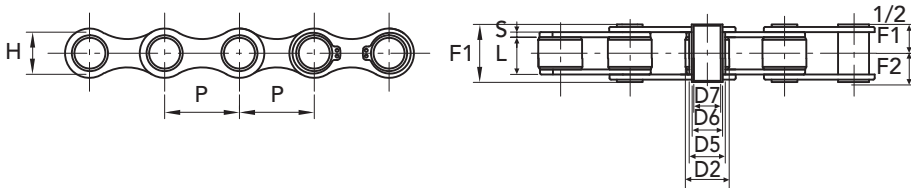

CHAIN	CHAIN P. NUMBER	COUPLING P. NUMBER	P mm	L mm	D2 mm	D5 mm	D6 mm	D7 mm	H mm	S mm	F1 mm	F2 mm	breaking load N. mm <sup>2</sup>	kg/m chain
1.3520 R	74605200	74605205	35	16	20	17	14	10,2	26	2,5	30	16,7	25000	2,20
1.3520 Z	74615200	74615205	35	16	20	17	14	10,2	26	2,5	30	16,7	25000	2,20

### A GALVANIZED BOLTS DRILLED

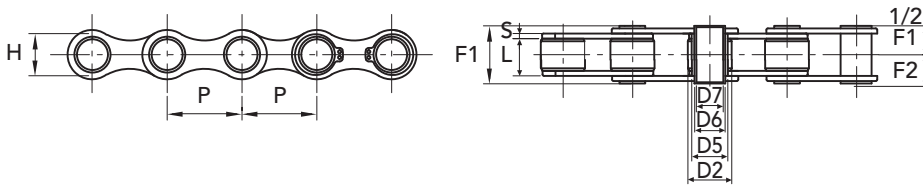

CHAIN	CHAIN P. NUMBER	COUPLING P. NUMBER	P mm	L mm	D1 mm	D5 mm	D6 mm	D7 mm	H mm	S mm	F1 mm	F2 mm	breaking load N. mm <sup>2</sup>	kg/m chain
1.1260 Z	74612600	74612605	41,75	20,5	17	13,8	11	8,3	21,4	3	36	22,7	27	1,50

### A PINS, PROJECTIONS GALVANIZED

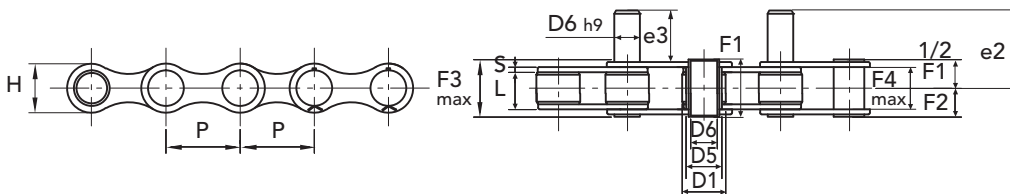

CHAIN	CHAIN P. NUMBER	COUPLING P. NUMBER	P mm	L mm	D1 mm	D5 mm	D6 mm	e2 mm	H mm	S mm	F1 mm	F2 mm	e3 mm	F3max mm	F4 min mm	breaking load N. mm <sup>2</sup>	kg/m chain
1.3521 Z	74615210	74615215	35	16	20	13	10	48,5	26	2,5	31	19	35	21	21,5	35000	2,80

CAD drawings available on our site [www.chiaravalli.com](http://www.chiaravalli.com)

Quantity, availability and prices on B2B Chiaravalli



# SPECIFIC ITEMS FOR TRANSMISSION WITH CHAIN

